

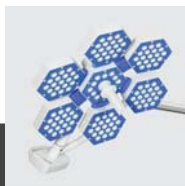

Technomed

Leading the Way

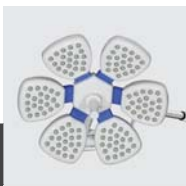

CATALOGUE NO. 12

LED OT LIGHTS & OPERATING TABLES

www.technomedindia.org

TECHNOMED INDIA is one of the prominent ISO 9001:2008, ISO 13485:2003, ISO 14001:2004, OHSAS 18001:2007, WHO/GMP & CE certificated Company, specializing in the production of Operation Theatre Lights and Tables in India, which is continued to be the trendsetter throughout the years of history. From the last 15 years, we have created a proficient niche both in the domestic and international medical industry, with its products sold nationwide and to countries and regions like Europe, The Middle East, South America, Africa and South East Asia. We have the privilege to design and distribute the most sophisticated and technological latest products in the service of medical profession. Our Research and Development department is continuously involved in designing & developing better design and technical solution at the required standard by the customers.

We are empowered with an efficient workforce of skilled and dedicated staff.

Our manufacturing facilities are located in Delhi, equipped with the latest machinery and all the work is done in house. While continuously increasing the production process, we also continuously improve the product quality.

We assure to satisfy you with our quality, workmanship and after sales service as we always do to meet the requests of our valuable customers. We give our customers a tailor made cost for cost effectiveness by keeping close watch at every step in order to give a personalized service. Motivated by the service philosophy of "Endeavor to affect customers". Technomed will, as always preserve in creating the new image of Indian Medical Equipments production and contribution to the health of all human beings around the world.

We can also manufacture the equipment according to your required specification as we are the original manufacturers, so please let us know if you need any change.

> Machine Process



> Technomed India



> Machine Process



> Machine Process



> Machine Process



> Smarturn LT Linear CNC Lathe Machine



> Dispatch



> Manufacturing Team



> Sales Team



INDEX

OMEGA

Series

1

NOVA

Series

3-9

HEX

Series

10-16

HEX CT

Series

17-21

C

Series

22-26

EXAMINATION

Lights

27

OT TABLES

Surgical / Ophthalmic / Gynae
/ Animal / Derma Chair

28-49

ACCESSORIES

Standard / Optional

50-51



Reliable and Effective

The design of the lighthouse shape fulfills the requirement of modern laminar flow OR

The open design of the light reduces the surface area that impedes the flow of air from the air supply ceilings, resulting in a less turbulent flow underneath the light.

- The totally enclosed lighthouse surface is very easy to decontaminate
- The lenses plate of the lighthouse is durable, ageing-resistant and easy to clean
- The handles of lighthouses can be easily removed for soaking and autoclavable disinfection



Control Panel

Touch control panel on the light head.

- On-Off
- Illumination intensity
- Color temperature
- Endo illumination mode



Safety Glass for Lens Protection

We offer LED lights with protective fire resistant ESG safety glass cover for scratch proof, fast disinfection process and improve the light penetration. It is made of monolayer safety glass which protects the lens from ultra-violet and infrared rays.

Maximum Economy and highest reliability

Its technological advances make it a good long term investment due to low maintenance and operating running cost. With various light head configurations, it maximizes the comfort of the surgeon and forbids the tissue dehydration even during long time operations.

- The minimal life expectancy of each LED is 50,000 hours
- Sophisticated LED thermal management keeps the temperature-rise of the space above surgeon's head and surgical region extremely low.

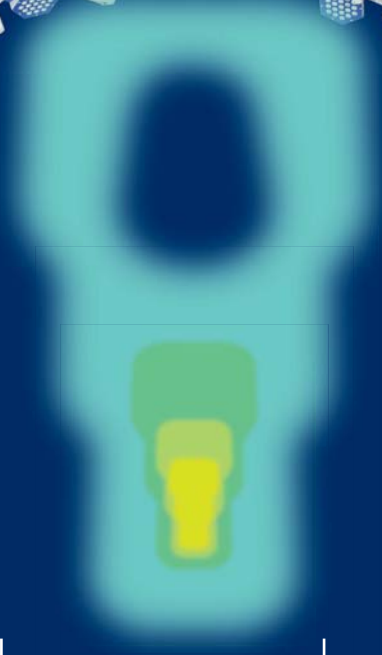

HD Documentation for Continuous Medical Education (CME)

- Auto focus
- Integrated central camera or independent third-arm camera (Optional)

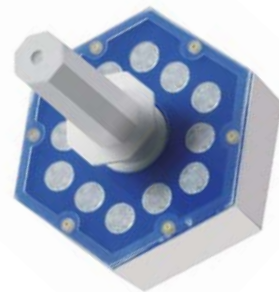

Sterilizable Handle

We provide high quality Sterilizable Handle.



Technomed
Leading the Way

Advanced and Perfect

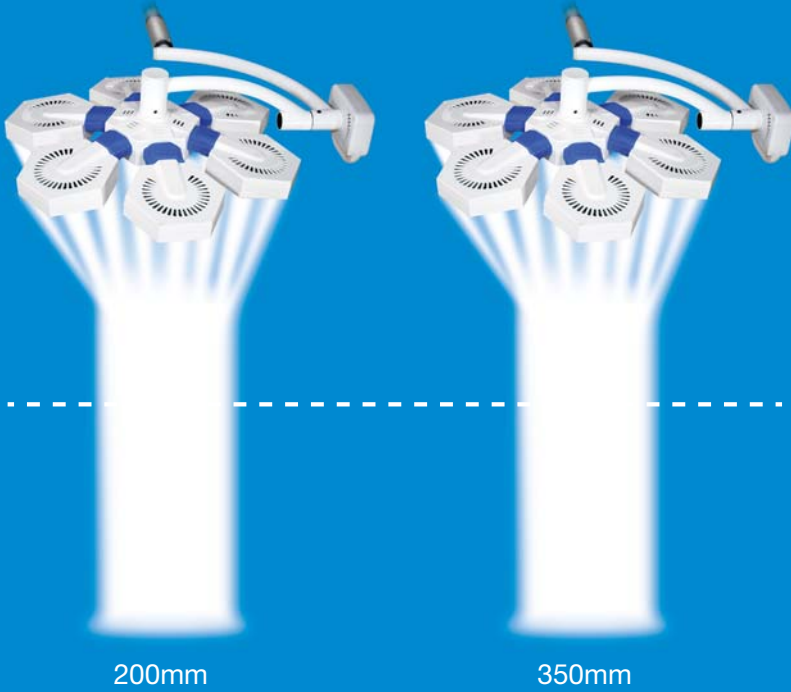

Focusing System

The brightness of different LEDs is adjusted automatically to change the spot size, which will avoid the possible occurrence of mechanical malfunctions.

LED
SERIES

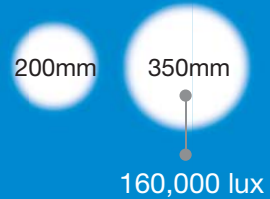

Supramaximal effective light field

With high light intensity and large spot size, 1200mm depth of field provides good lighting without having to refocus when the surgical wound location changes. The light head can be positioned for away from the wound to ensure better laminar flow.

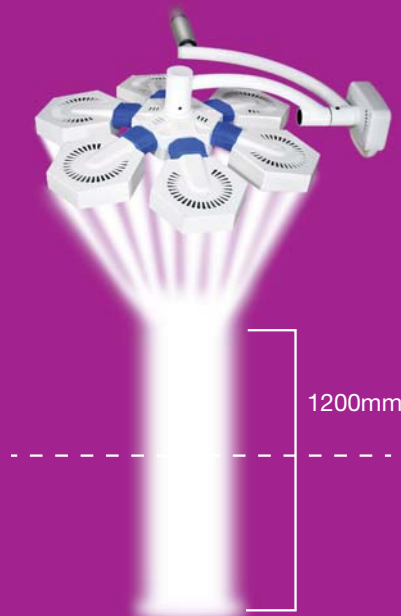

Endo Mode

To meet the requirement of low ambient illumination.



Perfect Shadow-free illuminance effect

Thanks to large amount of LED lights, and multiple emitting positions of LED light sources, any obstructions with surgeon's head, shoulder or hands will not affect the surgical wound area with any cast shadows.

OMEGA 500+500

Adjustable Colour Temperature

Special Features

Shadowless Light, Memory Function, High quality sterilizable handle, With protective fire resistant ESG safety glass for scratch proof, fast disinfection process, protects UV and IR rays and improve light penetration. Body is made of high quality fire resistant polymer.

Single non winged round shape lamp head for easy maintenance and better sealing against dust and fumigation.

OPTIONAL: BATTERY BACKUP 

Technical Data

Intensity	1,60,000 + 1,60,000 Lux ±10%
Size of Light Field	12-30 cm
Colour Temperature	4000-5000 K
Colour Rendering Index	93 RA
LED Life	>50000 Hrs.
Number of LED	126 +126
Diameter of Light	500mm x 2
Brightness Control	Capacitive Touch Panel
Power Supply	220V/50Hz AC
Colour of LED	White & Yellow (Double Colour)
Focusing	Adjustable
Monitor / Camera	Optional



**ULTRA-THIN
LED DOME**

Optional 360° Rotation

M Memory Function

E Endo Mode

OMEGA 500

Adjustable Colour Temperature

Special Features

Shadowless Light, Memory Function, High quality sterilizable handle, With protective fire resistant ESG safety glass for scratch proof, fast disinfection process, protects UV and IR rays and improve light penetration. Body is made of high quality fire resistant polymer.

Single non winged round shape lamp head for easy maintenance and better sealing against dust and fumigation.

OPTIONAL: BATTERY BACKUP 

Technical Data

Intensity	1,60,000 ±10%
Size of Light Field	12-30 cm
Colour Temperature	4000-5000 K
Colour Rendering Index	93 RA
LED Life	>50000 Hrs.
Number of LED	126
Diameter of Light	500mm
Brightness Control	Capacitive Touch Panel
Power Supply	220V/50Hz AC
Colour of LED	White & Yellow (Double Colour)
Focusing	Adjustable
Monitor / Camera	Optional



Mobile Model

**Mobile Model
with battery backup**

Optional 360° Rotation

M Memory Function

E Endo Mode

OMEGA 200+200

Special Features

Shadowless Light, Body is made of high quality fire resistant polymer.
Single non winged round shape lamp head for easy maintenance and better sealing against dust and fumigation.

OPTIONAL: BATTERY BACKUP 



Technical Data

Intensity	80,000 + 80,000 Lux ±10%
Size of Light Field	15 cm
Colour Temperature	5000 K
Colour Rendering Index	93 RA
LED Life	>50000 Hrs.
Number of LED	28 +28
Diameter of Light	200mm x 2
Brightness Control	Capacitive Touch Panel
Power Supply	220V/50Hz AC
Colour of LED	White
Focusing	Fixed

OMEGA 200

Special Features

Shadowless Light, Body is made of high quality fire resistant polymer.
Single non winged round shape lamp head for easy maintenance and better sealing against dust and fumigation.

OPTIONAL: BATTERY BACKUP 



Technical Data

Intensity	80,000 ±10%
Size of Light Field	15 cm
Colour Temperature	5000 K
Colour Rendering Index	93 RA
LED Life	>50000 Hrs.
Number of LED	28
Diameter of Light	200mm
Brightness Control	Capacitive Touch Panel
Power Supply	220V/50Hz AC
Colour of LED	White
Focusing	Fixed



TMI NOVA 6+6

Adjustable Colour Temperature

Special Features

Shadowless Light, Memory Function, High quality sterilizable handle. With special European design for ventilation of heat. Body is made of high quality fire resistant polymer.

OPTIONAL: BATTERY BACKUP 



Optional 360° Rotation

M Memory Function

E Endo Mode

Technical Data

Intensity	1,60,000 + 1,60,000 Lux ±10%
Size of Light Field	12-30 cm
Colour Temperature	4000-5000 K
Colour Rendering Index	93 RA
LED Life	>50000 Hrs.
Number of LED	126 +126
Diameter of Light	600mm x 2
Brightness Control	Capacitive Touch Panel
Power Supply	220V/50Hz AC
Colour of LED	White & Yellow (Double Colour)
Focusing	Adjustable

TMI NOVA 6+5

Adjustable Colour Temperature

Special Features

Shadowless Light, Memory Function, High quality sterilizable handle. With special European design for ventilation of heat. Body is made of high quality fire resistant polymer.

OPTIONAL: BATTERY BACKUP 



M Memory Function

E Endo Mode

Technical Data

Intensity	1,60,000 + 1,40,000 Lux ±10%
Size of Light Field	12-30 cm
Colour Temperature	4000-5000 K
Colour Rendering Index	93 RA
LED Life	>50000 Hrs.
Number of LED	126+105
Diameter of Light	600mm x 2
Brightness Control	Capacitive Touch Panel
Power Supply	220V/50Hz AC
Colour of LED	White & Yellow (Double Colour)
Focusing	Adjustable

TMI NOVA 6+4

Adjustable Colour Temperature

Special Features

Shadowless Light, Memory Function, High quality sterilizable handle. With special European design for ventilation of heat. Body is made of high quality fire resistant polymer.

OPTIONAL: BATTERY BACKUP 



Technical Data

Intensity	1,60,000 + 1,30,000 Lux ±10%
Size of Light Field	12-30 cm
Colour Temperature	4000-5000 K
Colour Rendering Index	93 RA
LED Life	>50000 Hrs.
Number of LED	126 + 84
Diameter of Light	600mm x 2
Brightness Control	Capacitive Touch Panel
Power Supply	220V/50Hz AC
Colour of LED	White & Yellow (Double Colour)
Focusing	Adjustable

M Memory Function

E Endo Mode

TMI NOVA 6+3

Adjustable Colour Temperature

Special Features

Shadowless Light, Memory Function, High quality sterilizable handle. With special European design for ventilation of heat. Body is made of high quality fire resistant polymer.

OPTIONAL: BATTERY BACKUP 



Technical Data

Intensity	1,60,000 + 1,00,000 Lux ±10%
Size of Light Field	12-30 cm
Colour Temperature	4000-5000 K
Colour Rendering Index	93 RA
LED Life	>50000 Hrs.
Number of LED	126 + 63
Diameter of Light	600mm x 2
Brightness Control	Capacitive Touch Panel
Power Supply	220V/50Hz AC
Colour of LED	White & Yellow (Double Colour)
Focusing	Adjustable

M Memory Function

E Endo Mode

TMI NOVA 5+5

Adjustable Colour Temperature

Special Features

Shadowless Light, Memory Function, High quality sterilizable handle. With special European design for ventilation of heat. Body is made of high quality fire resistant polymer.

OPTIONAL: BATTERY BACKUP 



Technical Data

Intensity	1,40,000 + 1,40,000 Lux ±10%
Size of Light Field	12-30 cm
Colour Temperature	4000-5000 K
Colour Rendering Index	93 RA
LED Life	>50000 Hrs.
Number of LED	105 + 105
Diameter of Light	600mm x 2
Brightness Control	Capacitive Touch Panel
Power Supply	220V/50Hz AC
Colour of LED	White & Yellow (Double Colour)
Focusing	Adjustable

M Memory Function

E Endo Mode

TMI NOVA 5+4

Adjustable Colour Temperature

Special Features

Shadowless Light, Memory Function, High quality sterilizable handle. With special European design for ventilation of heat. Body is made of high quality fire resistant polymer.

OPTIONAL: BATTERY BACKUP 



Technical Data

Intensity	1,40,000 + 1,30,000 Lux ±10%
Size of Light Field	12-30 cm
Colour Temperature	4000-5000 K
Colour Rendering Index	93 RA
LED Life	>50000 Hrs.
Number of LED	105 + 84
Diameter of Light	600mm x 2
Brightness Control	Capacitive Touch Panel
Power Supply	220V/50Hz AC
Colour of LED	White & Yellow (Double Colour)
Focusing	Adjustable

M Memory Function

E Endo Mode

TMI NOVA 5+3

Adjustable Colour Temperature

Special Features

Shadowless Light, Memory Function, High quality sterilizable handle. With special European design for ventilation of heat. Body is made of high quality fire resistant polymer.

OPTIONAL: BATTERY BACKUP 

Technical Data

Intensity	1,40,000 + 1,00,000 Lux ±10%
Size of Light Field	12-30 cm
Colour Temperature	4000-5000 K
Colour Rendering Index	93 RA
LED Life	>50000 Hrs.
Number of LED	105 + 63
Diameter of Light	600mm x 2
Brightness Control	Capacitive Touch Panel
Power Supply	220V/50Hz AC
Colour of LED	White & Yellow (Double Colour)
Focusing	Adjustable



M Memory Function

E Endo Mode

TMI NOVA 4+4

Adjustable Colour Temperature

Special Features

Shadowless Light, Memory Function, High quality sterilizable handle. With special European design for ventilation of heat. Body is made of high quality fire resistant polymer.

OPTIONAL: BATTERY BACKUP 

Technical Data

Intensity	1,30,000 + 1,30,000 Lux ±10%
Size of Light Field	12-30 cm
Colour Temperature	4000-5000 K
Colour Rendering Index	93 RA
LED Life	>50000 Hrs.
Number of LED	84 + 84
Diameter of Light	600mm x 2
Brightness Control	Capacitive Touch Panel
Power Supply	220V/50Hz AC
Colour of LED	White & Yellow (Double Colour)
Focusing	Adjustable



M Memory Function

E Endo Mode

TMI NOVA 4+3

Adjustable Colour Temperature

Special Features

Shadowless Light, Memory Function, High quality sterilizable handle. With special European design for ventilation of heat. Body is made of high quality fire resistant polymer.

OPTIONAL: BATTERY BACKUP 

Technical Data

Intensity	1,30,000 + 1,00,000 Lux ±10%
Size of Light Field	12-30 cm
Colour Temperature	4000-5000 K
Colour Rendering Index	93 RA
LED Life	>50000 Hrs.
Number of LED	84 + 63
Diameter of Light	600mm x 2
Brightness Control	Capacitive Touch Panel
Power Supply	220V/50Hz AC
Colour of LED	White & Yellow (Double Colour)
Focusing	Adjustable



M Memory Function

E Endo Mode

TMI NOVA 3+3

Adjustable Colour Temperature

Special Features

Shadowless Light, Memory Function, High quality sterilizable handle. With special European design for ventilation of heat. Body is made of high quality fire resistant polymer.

OPTIONAL: BATTERY BACKUP 

Technical Data

Intensity	1,00,000 + 1,00,000 Lux ±10%
Size of Light Field	12-30 cm
Colour Temperature	4000-5000 K
Colour Rendering Index	93 RA
LED Life	>50000 Hrs.
Number of LED	63 + 63
Diameter of Light	600mm x 2
Brightness Control	Capacitive Touch Panel
Power Supply	220V/50Hz AC
Colour of LED	White & Yellow (Double Colour)
Focusing	Adjustable



M Memory Function

E Endo Mode

TMI NOVA 6

Adjustable Colour Temperature

Special Features

Shadowless Light, Memory Function, High quality sterilizable handle. With special European design for ventilation of heat. Body is made of high quality fire resistant polymer.

OPTIONAL: BATTERY BACKUP 



M Memory Function

E Endo Mode

Technical Data

Intensity	1,60,000 Lux ±10%
Size of Light Field	12-30 cm
Colour Temperature	4000-5000 K
Colour Rendering Index	93 RA
LED Life	>50000 Hrs.
Number of LED	126
Diameter of Light	600mm
Brightness Control	Capacitive Touch Panel
Power Supply	220V/50Hz AC
Colour of LED	White & Yellow (Double Colour)
Focusing	Adjustable



Mobile Model

Mobile Model with battery backup

TMI NOVA 5

Adjustable Colour Temperature

Special Features

Shadowless Light, Memory Function, High quality sterilizable handle. With special European design for ventilation of heat. Body is made of high quality fire resistant polymer.

OPTIONAL: BATTERY BACKUP 



M Memory Function

E Endo Mode

Technical Data

Intensity	1,40,000 Lux ±10%
Size of Light Field	12-30 cm
Colour Temperature	4000-5000 K
Colour Rendering Index	93 RA
LED Life	>50000 Hrs.
Number of LED	105
Diameter of Light	600mm
Brightness Control	Capacitive Touch Panel
Power Supply	220V/50Hz AC
Colour of LED	White & Yellow (Double Colour)
Focusing	Adjustable



Mobile Model

Mobile Model with battery backup

TMI NOVA 4

Adjustable Colour Temperature

Special Features

Shadowless Light, Memory Function, High quality sterilizable handle. With special European design for ventilation of heat. Body is made of high quality fire resistant polymer.

OPTIONAL: BATTERY BACKUP 



M Memory Function

E Endo Mode

Technical Data

Intensity	1,30,000 Lux ±10%
Size of Light Field	12-30 cm
Colour Temperature	4000-5000 K
Colour Rendering Index	93 RA
LED Life	>50000 Hrs.
Number of LED	84
Diameter of Light	600mm
Brightness Control	Capacitive Touch Panel
Power Supply	220V/50Hz AC
Colour of LED	White & Yellow (Double Colour)
Focusing	Adjustable



Mobile Model

Mobile Model
with battery backup

TMI NOVA 3

Adjustable Colour Temperature

Special Features

Shadowless Light, Memory Function, High quality sterilizable handle. With special European design for ventilation of heat. Body is made of high quality fire resistant polymer.

OPTIONAL: BATTERY BACKUP 



M Memory Function

E Endo Mode

Technical Data

Intensity	1,00,000 Lux ±10%
Size of Light Field	12-30 cm
Colour Temperature	4000-5000 K
Colour Rendering Index	93 RA
LED Life	>50000 Hrs.
Number of LED	63
Diameter of Light	600mm
Brightness Control	Capacitive Touch Panel
Power Supply	220V/50Hz AC
Colour of LED	White & Yellow (Double Colour)
Focusing	Adjustable



Mobile Model

Mobile Model
with battery backup

TMI HEX 126+126

Adjustable Colour Temperature

Special Features

Shadowless Light, Memory Function, High quality sterilizable handle, With protective fire resistant ESG safety glass for scratch proof, fast disinfection process, protects UV and IR rays and improve light penetration. With special European design for ventilation of heat. Body is made of high quality fire resistant polymer.

OPTIONAL: BATTERY BACKUP



Optional 360° Rotation

M Memory Function

E Endo Mode

Technical Data

Intensity	1,60,000 + 1,60,000 Lux ±10%
Size of Light Field	12-30 cm
Colour Temperature	4000-5000 K
Colour Rendering Index	93 RA
LED Life	>50000 Hrs.
Number of LED	126 +126
Diameter of Light	500mm x 2
Brightness Control	Capacitive Touch Panel
Power Supply	220V/50Hz AC
Colour of LED	White & Yellow (Double Colour)
Focusing	Adjustable

Easily detachable connector based OT Light / Optional

TMI HEX 126+105

Adjustable Colour Temperature

Special Features

Shadowless Light, Memory Function, High quality sterilizable handle, With protective fire resistant ESG safety glass for scratch proof, fast disinfection process, protects UV and IR rays and improve light penetration. With special European design for ventilation of heat. Body is made of high quality fire resistant polymer.

OPTIONAL: BATTERY BACKUP



M Memory Function

E Endo Mode

Technical Data

Intensity	1,50,000 +1,60,000 Lux ±10%
Size of Light Field	12-30 cm
Colour Temperature	4000-5000 K
Colour Rendering Index	93 RA
LED Life	>50000 Hrs.
Number of LED	105 + 126
Diameter of Light	500mm x 2
Brightness Control	Capacitive Touch Panel
Power Supply	220V/50Hz AC
Colour of LED	White & Yellow (Double Colour)
Focusing	Adjustable

Easily detachable connector based OT Light / Optional

TMI HEX 126+84

Adjustable Colour Temperature

Special Features

Shadowless Light, Memory Function, High quality sterilizable handle, With protective fire resistant ESG safety glass for scratch proof, fast disinfection process, protects UV and IR rays and improve light penetration. With special European design for ventilation of heat. Body is made of high quality fire resistant polymer.

OPTIONAL: BATTERY BACKUP



Technical Data

Intensity	1,30,000 + 1,60,000 Lux ±10%
Size of Light Field	12-30 cm
Colour Temperature	4000-5000 K
Colour Rendering Index	93 RA
LED Life	>50000 Hrs.
Number of LED	84 + 126
Diameter of Light	500mm x 2
Brightness Control	Capacitive Touch Panel
Power Supply	220V/50Hz AC
Colour of LED	White & Yellow (Double Colour)
Focusing	Adjustable

Easily detachable connector based OT Light / Optional

M Memory Function

E Endo Mode

TMI HEX 126+63

Adjustable Colour Temperature

Special Features

Shadowless Light, Memory Function, High quality sterilizable handle, With protective fire resistant ESG safety glass for scratch proof, fast disinfection process, protects UV and IR rays and improve light penetration. With special European design for ventilation of heat. Body is made of high quality fire resistant polymer.

OPTIONAL: BATTERY BACKUP



Technical Data

Intensity	1,60,000 + 90,000 Lux ±10%
Size of Light Field	12-30 cm
Colour Temperature	4000-5000 K
Colour Rendering Index	93 RA
LED Life	>50000 Hrs.
Number of LED	126 + 63
Diameter of Light	500mm x 2
Brightness Control	Capacitive Touch Panel
Power Supply	220V/50Hz AC
Colour of LED	White & Yellow (Double Colour)
Focusing	Adjustable

Easily detachable connector based OT Light / Optional

M Memory Function

E Endo Mode

TMI HEX 105+105

Adjustable Colour Temperature

Special Features

Shadowless Light, Memory Function, High quality sterilizable handle, With protective fire resistant ESG safety glass for scratch proof, fast disinfection process, protects UV and IR rays and improve light penetration. With special European design for ventilation of heat. Body is made of high quality fire resistant polymer.

OPTIONAL: BATTERY BACKUP 



M Memory Function

E Endo Mode

Technical Data

Intensity	1,50,000 + 1,50,000 Lux ±10%
Size of Light Field	12-30 cm
Colour Temperature	4000-5000 K
Colour Rendering Index	93 RA
LED Life	>50000 Hrs.
Number of LED	105 + 105
Diameter of Light	500mm x 2
Brightness Control	Capacitive Touch Panel
Power Supply	220V/50Hz AC
Colour of LED	White & Yellow (Double Colour)
Focusing	Adjustable

Easily detachable connector based OT Light / Optional

TMI HEX 105+84

Adjustable Colour Temperature

Special Features

Shadowless Light, Memory Function, High quality sterilizable handle, With protective fire resistant ESG safety glass for scratch proof, fast disinfection process, protects UV and IR rays and improve light penetration. With special European design for ventilation of heat. Body is made of high quality fire resistant polymer.

OPTIONAL: BATTERY BACKUP 



M Memory Function

E Endo Mode

Technical Data

Intensity	1,50,000 + 1,30,000 Lux ±10%
Size of Light Field	12-30 cm
Colour Temperature	4000-5000 K
Colour Rendering Index	93 RA
LED Life	>50000 Hrs.
Number of LED	105 + 84
Diameter of Light	500mm x 2
Brightness Control	Capacitive Touch Panel
Power Supply	220V/50Hz AC
Colour of LED	White & Yellow (Double Colour)
Focusing	Adjustable

Easily detachable connector based OT Light / Optional

TMI HEX 105+63

Adjustable Colour Temperature

Special Features

Shadowless Light, Memory Function, High quality sterilizable handle, With protective fire resistant ESG safety glass for scratch proof, fast disinfection process, protects UV and IR rays and improve light penetration. With special European design for ventilation of heat. Body is made of high quality fire resistant polymer.

OPTIONAL: BATTERY BACKUP



M Memory Function

E Endo Mode

Technical Data

Intensity	1,50,000 + 90,000 Lux ±10%
Size of Light Field	12-30 cm
Colour Temperature	4000-5000 K
Colour Rendering Index	93 RA
LED Life	>50000 Hrs.
Number of LED	105 + 63
Diameter of Light	500mm x 2
Brightness Control	Capacitive Touch Panel
Power Supply	220V/50Hz AC
Colour of LED	White & Yellow (Double Colour)
Focusing	Adjustable

Easily detachable connector based OT Light / Optional

TMI HEX 84+84

Adjustable Colour Temperature

Special Features

Shadowless Light, Memory Function, High quality sterilizable handle, With protective fire resistant ESG safety glass for scratch proof, fast disinfection process, protects UV and IR rays and improve light penetration. With special European design for ventilation of heat. Body is made of high quality fire resistant polymer.

OPTIONAL: BATTERY BACKUP



M Memory Function

E Endo Mode

Technical Data

Intensity	1,30,000 + 1,30,000 Lux ±10%
Size of Light Field	12-30 cm
Colour Temperature	4000-5000 K
Colour Rendering Index	93 RA
LED Life	>50000 Hrs.
Number of LED	84 + 84
Diameter of Light	500mm x 2
Brightness Control	Capacitive Touch Panel
Power Supply	220V/50Hz AC
Colour of LED	White & Yellow (Double Colour)
Focusing	Adjustable

Easily detachable connector based OT Light / Optional

TMI HEX 84+63

Adjustable Colour Temperature

Special Features

Shadowless Light, Memory Function, High quality sterilizable handle, With protective fire resistant ESG safety glass for scratch proof, fast disinfection process, protects UV and IR rays and improve light penetration. With special European design for ventilation of heat. Body is made of high quality fire resistant polymer.

OPTIONAL: BATTERY BACKUP



Technical Data

Intensity	1,30,000 + 90,000 Lux ±10%
Size of Light Field	12-30 cm
Colour Temperature	4000-5000 K
Colour Rendering Index	93 RA
LED Life	>50000 Hrs.
Number of LED	84 + 63
Diameter of Light	500mm x 2
Brightness Control	Capacitive Touch Panel
Power Supply	220V/50Hz AC
Colour of LED	White & Yellow (Double Colour)
Focusing	Adjustable

Easily detachable connector based OT Light / Optional

M Memory Function

E Endo Mode

TMI HEX 63+63

Adjustable Colour Temperature

Special Features

Shadowless Light, Memory Function, High quality sterilizable handle, With protective fire resistant ESG safety glass for scratch proof, fast disinfection process, protects UV and IR rays and improve light penetration. With special European design for ventilation of heat. Body is made of high quality fire resistant polymer.

OPTIONAL: BATTERY BACKUP



Technical Data

Intensity	90,000 + 90,000 Lux ±10%
Size of Light Field	12-30 cm
Colour Temperature	4000-5000 K
Colour Rendering Index	93 RA
LED Life	>50000 Hrs.
Number of LED	63 + 63
Diameter of Light	500mm x 2
Brightness Control	Capacitive Touch Panel
Power Supply	220V/50Hz AC
Colour of LED	White & Yellow (Double Colour)
Focusing	Adjustable

Easily detachable connector based OT Light / Optional

M Memory Function

E Endo Mode

TMI HEX 126

Adjustable Colour Temperature

Special Features

Shadowless Light, Memory Function, High quality sterilizable handle, With protective fire resistant ESG safety glass for scratch proof, fast disinfection process, protects UV and IR rays and improve light penetration. With special European design for ventilation of heat. Body is made of high quality fire resistant polymer.

OPTIONAL: BATTERY BACKUP 

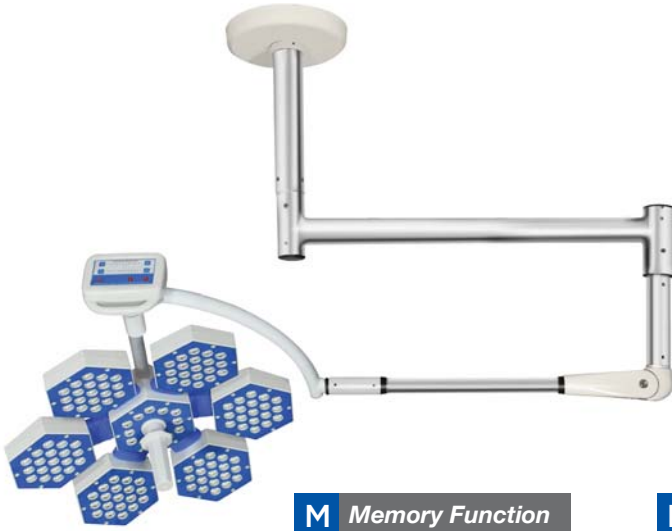

M Memory Function

E Endo Mode

Technical Data

Intensity	1,60,000 Lux ±10%
Size of Light Field	12-30 cm
Colour Temperature	4000-5000 K
Colour Rendering Index	93 RA
LED Life	>50000 Hrs.
Number of LED	126
Diameter of Light	500mm
Brightness Control	Capacitive Touch Panel
Power Supply	220V/50Hz AC
Colour of LED	White & Yellow (Double Colour)
Focusing	Adjustable

Easily detachable connector based OT Light / Optional



Mobile Model

Mobile Model with battery backup

TMI HEX 105

Adjustable Colour Temperature

Special Features

Shadowless Light, Memory Function, High quality sterilizable handle, With protective fire resistant ESG safety glass for scratch proof, fast disinfection process, protects UV and IR rays and improve light penetration. With special European design for ventilation of heat. Body is made of high quality fire resistant polymer.

OPTIONAL: BATTERY BACKUP 



M Memory Function

E Endo Mode

Technical Data

Intensity	1,50,000 Lux ±10%
Size of Light Field	12-30 cm
Colour Temperature	4000-5000 K
Colour Rendering Index	93 RA
LED Life	>50000 Hrs.
Number of LED	105
Diameter of Light	500mm
Brightness Control	Capacitive Touch Panel
Power Supply	220V/50Hz AC
Colour of LED	White & Yellow (Double Colour)
Focusing	Adjustable

Easily detachable connector based OT Light / Optional



Mobile Model

Mobile Model with battery backup

TMI HEX 84

Adjustable Colour Temperature

Special Features

Shadowless Light, Memory Function, High quality sterilizable handle, With protective fire resistant ESG safety glass for scratch proof, fast disinfection process, protects UV and IR rays and improve light penetration. With special European design for ventilation of heat. Body is made of high quality fire resistant polymer.

OPTIONAL: BATTERY BACKUP 



M Memory Function

E Endo Mode

Technical Data

Intensity	1,30,000 Lux ±10%
Size of Light Field	12-30 cm
Colour Temperature	4000-5000 K
Colour Rendering Index	93 RA
LED Life	>50000 Hrs.
Number of LED	84
Diameter of Light	500mm
Brightness Control	Capacitive Touch Panel
Power Supply	220V/50Hz AC
Colour of LED	White & Yellow (Double Colour)
Focusing	Adjustable

Easily detachable connector based OT Light / Optional



Mobile Model



Mobile Model with battery backup

TMI HEX 63

Adjustable Colour Temperature

Special Features

Shadowless Light, Memory Function, High quality sterilizable handle, With protective fire resistant ESG safety glass for scratch proof, fast disinfection process, protects UV and IR rays and improve light penetration. With special European design for ventilation of heat. Body is made of high quality fire resistant polymer.

OPTIONAL: BATTERY BACKUP 



M Memory Function

E Endo Mode

Technical Data

Intensity	90,000 Lux ±10%
Size of Light Field	12-30 cm
Colour Temperature	4000-5000 K
Colour Rendering Index	93 RA
LED Life	>50000 Hrs.
Number of LED	63
Diameter of Light	500mm
Brightness Control	Capacitive Touch Panel
Power Supply	220V/50Hz AC
Colour of LED	White & Yellow (Double Colour)
Focusing	Adjustable

Easily detachable connector based OT Light / Optional



Mobile Model



Mobile Model with battery backup

TMI HEX CT 5+5

Adjustable Colour Temperature

Special Features

Shadowless Light, Memory Function, High quality sterilizable handle, With protective fire resistant ESG safety glass for scratch proof, fast disinfection process, protects UV and IR rays and improve light penetration. With special European design for ventilation of heat. Body is made of high quality fire resistant polymer.

OPTIONAL: BATTERY BACKUP



Technical Data

Intensity	1,40,000 + 1,40,000 Lux ±10%
Size of Light Field	12-30 cm
Colour Temperature	4000-5000 K
Colour Rendering Index	93 RA
LED Life	>50000 Hrs.
Number of LED	95 + 95
Diameter of Light	500mm x 2
Brightness Control	Capacitive Touch Panel
Power Supply	220V/50Hz AC
Colour of LED	White & Yellow (Double Colour)
Focusing	Adjustable

M Memory Function

E Endo Mode

TMI HEX CT 5+4

Adjustable Colour Temperature

Special Features

Shadowless Light, Memory Function, High quality sterilizable handle, With protective fire resistant ESG safety glass for scratch proof, fast disinfection process, protects UV and IR rays and improve light penetration. With special European design for ventilation of heat. Body is made of high quality fire resistant polymer.

OPTIONAL: BATTERY BACKUP



Technical Data

Intensity	1,40,000 + 1,10,000 Lux ±10%
Size of Light Field	12-30 cm
Colour Temperature	4000-5000 K
Colour Rendering Index	93 RA
LED Life	>50000 Hrs.
Number of LED	95 + 76
Diameter of Light	500mm x 2
Brightness Control	Capacitive Touch Panel
Power Supply	220V/50Hz AC
Colour of LED	White & Yellow (Double Colour)
Focusing	Adjustable

M Memory Function

E Endo Mode

TMI HEX CT 5+3

Adjustable Colour Temperature

Special Features

Shadowless Light, Memory Function, High quality sterilizable handle, With protective fire resistant ESG safety glass for scratch proof, fast disinfection process, protects UV and IR rays and improve light penetration. With special European design for ventilation of heat. Body is made of high quality fire resistant polymer.

OPTIONAL: BATTERY BACKUP 



M Memory Function

E Endo Mode

Technical Data

Intensity	80,000 + 1,40,000 Lux ±10%
Size of Light Field	12-30 cm
Colour Temperature	4000-5000 K
Colour Rendering Index	93 RA
LED Life	>50000 Hrs.
Number of LED	57 + 95
Diameter of Light	500mm x 2
Brightness Control	Capacitive Touch Panel
Power Supply	220V/50Hz AC
Colour of LED	White & Yellow (Double Colour)
Focusing	Adjustable

TMI HEX CT 4+4

Adjustable Colour Temperature

Special Features

Shadowless Light, Memory Function, High quality sterilizable handle, With protective fire resistant ESG safety glass for scratch proof, fast disinfection process, protects UV and IR rays and improve light penetration. With special European design for ventilation of heat. Body is made of high quality fire resistant polymer.

OPTIONAL: BATTERY BACKUP 



M Memory Function

E Endo Mode

Technical Data

Intensity	1,10,000 + 1,10,000 Lux ±10%
Size of Light Field	12-30 cm
Colour Temperature	4000-5000 K
Colour Rendering Index	93 RA
LED Life	>50000 Hrs.
Number of LED	76 + 76
Diameter of Light	500mm x 2
Brightness Control	Capacitive Touch Panel
Power Supply	220V/50Hz AC
Colour of LED	White & Yellow (Double Colour)
Focusing	Adjustable

TMI HEX CT 4+3

Adjustable Colour Temperature

Special Features

Shadowless Light, Memory Function, High quality sterilizable handle, With protective fire resistant ESG safety glass for scratch proof, fast disinfection process, protects UV and IR rays and improve light penetration. With special European design for ventilation of heat. Body is made of high quality fire resistant polymer.

OPTIONAL: BATTERY BACKUP 



M Memory Function

E Endo Mode

Technical Data

Intensity	80,000 + 1,10,000 Lux ±10%
Size of Light Field	12-30 cm
Colour Temperature	4000-5000 K
Colour Rendering Index	93 RA
LED Life	>50000 Hrs.
Number of LED	57 + 76
Diameter of Light	500mm x 2
Brightness Control	Capacitive Touch Panel
Power Supply	220V/50Hz AC
Colour of LED	White & Yellow (Double Colour)
Focusing	Adjustable

TMI HEX CT 3+3

Adjustable Colour Temperature

Special Features

Shadowless Light, Memory Function, High quality sterilizable handle, With protective fire resistant ESG safety glass for scratch proof, fast disinfection process, protects UV and IR rays and improve light penetration. With special European design for ventilation of heat. Body is made of high quality fire resistant polymer.

OPTIONAL: BATTERY BACKUP 



M Memory Function

E Endo Mode

Technical Data

Intensity	80,000 + 80,000 Lux ±10%
Size of Light Field	12-30 cm
Colour Temperature	4000-5000 K
Colour Rendering Index	93 RA
LED Life	>50000 Hrs.
Number of LED	57 + 57
Diameter of Light	500mm x 2
Brightness Control	Capacitive Touch Panel
Power Supply	220V/50Hz AC
Colour of LED	White & Yellow (Double Colour)
Focusing	Adjustable

TMI HEX CT 5

Adjustable Colour Temperature

Special Features

Shadowless Light, Memory Function, High quality sterilizable handle, With protective fire resistant ESG safety glass for scratch proof, fast disinfection process, protects UV and IR rays and improve light penetration. With special European design for ventilation of heat. Body is made of high quality fire resistant polymer.

OPTIONAL: BATTERY BACKUP 



M Memory Function

E Endo Mode

Technical Data

Intensity	1,40,000 Lux ±10%
Size of Light Field	12-30 cm
Colour Temperature	4000-5000 K
Colour Rendering Index	93 RA
LED Life	>50000 Hrs.
Number of LED	95
Diameter of Light	500mm
Brightness Control	Capacitive Touch Panel
Power Supply	220V/50Hz AC
Colour of LED	White & Yellow (Double Colour)
Focusing	Adjustable



Mobile Model



Mobile Model with battery backup

TMI HEX CT 4

Adjustable Colour Temperature

Special Features

Shadowless Light, Memory Function, High quality sterilizable handle, With protective fire resistant ESG safety glass for scratch proof, fast disinfection process, protects UV and IR rays and improve light penetration. With special European design for ventilation of heat. Body is made of high quality fire resistant polymer.

OPTIONAL: BATTERY BACKUP 



M Memory Function

E Endo Mode

Technical Data

Intensity	1,10,000 Lux ±10%
Size of Light Field	12-30 cm
Colour Temperature	4000-5000 K
Colour Rendering Index	93 RA
LED Life	>50000 Hrs.
Number of LED	76
Diameter of Light	500mm
Brightness Control	Capacitive Touch Panel
Power Supply	220V/50Hz AC
Colour of LED	White & Yellow (Double Colour)
Focusing	Adjustable



Mobile Model



Mobile Model with battery backup

TMI HEX CT 3

Adjustable Colour Temperature

Special Features

Shadowless Light, Memory Function, High quality sterilizable handle, With protective fire resistant ESG safety glass for scratch proof, fast disinfection process, protects UV and IR rays and improve light penetration. With special European design for ventilation of heat. Body is made of high quality fire resistant polymer.

OPTIONAL: BATTERY BACKUP 

Technical Data

Intensity	80,000 Lux ±10%
Size of Light Field	12-30 cm
Colour Temperature	4000-5000 K
Colour Rendering Index	93 RA
LED Life	>50000 Hrs.
Number of LED	57
Diameter of Light	500mm
Brightness Control	Capacitive Touch Panel
Power Supply	220V/50Hz AC
Colour of LED	White & Yellow (Double Colour)
Focusing	Adjustable



M *Memory Function*



E *Endo Mode*



Mobile Model

Mobile Model with battery backup



TMI C 5+5

Special Features

Shadowless Light, High quality sterilizable handle. With special European design for ventilation of heat. Body is made of high quality fire resistant polymer. With Dual Colour LED White and Yellow.

OPTIONAL: BATTERY BACKUP 



Optional All LED in White Colour

Technical Data

Intensity	130,000 + 130,000 ±10%
Size of Light Field	12-30 cm
Colour Temperature	4000-5000 K
Colour Rendering Index	93 RA
LED Life	>50000 Hrs.
Number of LED	70 + 70
Diameter of Light	500mm x 2
Power Supply	220V/50Hz AC
Focusing	Adjustable

TMI C 5+4

Special Features

Shadowless Light, High quality sterilizable handle. With special European design for ventilation of heat. Body is made of high quality fire resistant polymer. With Dual Colour LED White and Yellow.

OPTIONAL: BATTERY BACKUP 



Optional All LED in White Colour

Technical Data

Intensity	130,000 + 100,000 ±10%
Size of Light Field	12-30 cm
Colour Temperature	4000-5000 K
Colour Rendering Index	93 RA
LED Life	>50000 Hrs.
Number of LED	70 + 56
Diameter of Light	500mm x 2
Power Supply	220V/50Hz AC
Focusing	Adjustable

TMI C 5+3

Special Features

Shadowless Light, High quality sterilizable handle. With special European design for ventilation of heat. Body is made of high quality fire resistant polymer. With Dual Colour LED White and Yellow.

OPTIONAL: BATTERY BACKUP 



Optional All LED in White Colour

Technical Data

Intensity	130,000 + 80,000 ±10%
Size of Light Field	12-30 cm
Colour Temperature	4000-5000 K
Colour Rendering Index	93 RA
LED Life	>50000 Hrs.
Number of LED	70 + 42
Diameter of Light	500mm x 2
Power Supply	220V/50Hz AC
Focusing	Adjustable

TMI C 4+4

Special Features

Shadowless Light, High quality sterilizable handle. With special European design for ventilation of heat. Body is made of high quality fire resistant polymer. With Dual Colour LED White and Yellow.

OPTIONAL: BATTERY BACKUP 



Optional All LED in White Colour

Technical Data

Intensity	100,000 + 100,000 ±10%
Size of Light Field	12-30 cm
Colour Temperature	4000-5000 K
Colour Rendering Index	93 RA
LED Life	>50000 Hrs.
Number of LED	56 + 56
Diameter of Light	500mm x 2
Power Supply	220V/50Hz AC
Focusing	Adjustable

TMI C 4+3

Special Features

Shadowless Light, High quality sterilizable handle. With special European design for ventilation of heat. Body is made of high quality fire resistant polymer. With Dual Colour LED White and Yellow.

OPTIONAL: BATTERY BACKUP 

Technical Data

Intensity	100,000 + 80,000 ±10%
Size of Light Field	12-30 cm
Colour Temperature	4000-5000 K
Colour Rendering Index	93 RA
LED Life	>50000 Hrs.
Number of LED	56 + 42
Diameter of Light	500mm x 2
Power Supply	220V/50Hz AC
Focusing	Adjustable



Optional All LED in White Colour

TMI C 3+3

Special Features

Shadowless Light, High quality sterilizable handle. With special European design for ventilation of heat. Body is made of high quality fire resistant polymer. With Dual Colour LED White and Yellow.

OPTIONAL: BATTERY BACKUP 

Technical Data

Intensity	80,000 + 80,000 ±10%
Size of Light Field	12-30 cm
Colour Temperature	4000-5000 K
Colour Rendering Index	93 RA
LED Life	>50000 Hrs.
Number of LED	42 + 42
Diameter of Light	500mm x 2
Power Supply	220V/50Hz AC
Focusing	Adjustable



Optional All LED in White Colour

TMI C 5

Special Features

Shadowless Light, High quality sterilizable handle. With special European design for ventilation of heat. Body is made of high quality fire resistant polymer. With Dual Colour LED White and Yellow.

OPTIONAL: BATTERY BACKUP 



Optional All LED in White Colour

Technical Data

Intensity	130,000 ±10%
Size of Light Field	12-30 cm
Colour Temperature	4000-5000 K
Colour Rendering Index	93 RA
LED Life	>50000 Hrs.
Number of LED	70
Diameter of Light	500mm
Power Supply	220V/50Hz AC
Focusing	Adjustable



Mobile Model

Mobile Model with battery backup

TMI C 4

Special Features

Shadowless Light, High quality sterilizable handle. With special European design for ventilation of heat. Body is made of high quality fire resistant polymer. With Dual Colour LED White and Yellow.

OPTIONAL: BATTERY BACKUP 



Optional All LED in White Colour

Technical Data

Intensity	100,000 ±10%
Size of Light Field	12-30 cm
Colour Temperature	4000-5000 K
Colour Rendering Index	93 RA
LED Life	>50000 Hrs.
Number of LED	56
Diameter of Light	500mm
Power Supply	220V/50Hz AC
Focusing	Adjustable



Mobile Model

Mobile Model with battery backup

TMI C 3

Special Features

Shadowless Light, High quality sterilizable handle. With special European design for ventilation of heat. Body is made of high quality fire resistant polymer. With Dual Colour LED White and Yellow.

OPTIONAL: BATTERY BACKUP 

Technical Data

Intensity	80,000 ±10%
Size of Light Field	12-30 cm
Colour Temperature	4000-5000 K
Colour Rendering Index	93 RA
LED Life	>50000 Hrs.
Number of LED	42
Diameter of Light	500mm
Power Supply	220V/50Hz AC
Focusing	Adjustable



Optional All LED in White Colour



Mobile Model

Mobile Model with battery backup



TMI EL-NOVA

Special Features

Shadowless Light, With special European design for ventilation of heat. Body is made of high quality fire resistant polymer. With Dual Colour LED White and Yellow.

OPTIONAL: BATTERY BACKUP



Technical Data

Intensity	55,000 Lux \pm 10%
Size of Light Field	125mm
Colour Temperature	4500-5000 K
Colour Rendering Index	93 RA
LED Life	>50000 Hrs.
Number of LED	21
Brightness Control	Touch
Diameter of Light	150mm
Power Supply	220V/50Hz AC



Wall Mounted

Wall Mounted with Extended Rod

Note: Also available Table Mounted

TMI EL-HEX

Special Features

Shadowless Light, With special European design for ventilation of heat. Body is made of high quality fire resistant polymer. With Dual Colour LED White and Yellow.

OPTIONAL: BATTERY BACKUP

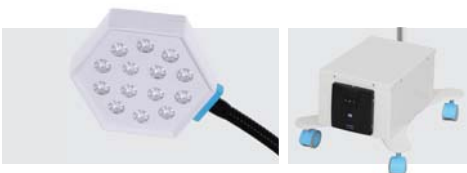

Technical Data

Intensity	45,000 Lux \pm 10%
Size of Light Field	125mm
Colour Temperature	4500-5000 K
Colour Rendering Index	93 RA
LED Life	>50000 Hrs.
Number of LED	14
Brightness Control	Touch
Diameter of Light	150mm
Power Supply	220V/50Hz AC



Wall Mounted

Wall Mounted with Extended Rod

Note: Also available Table Mounted

TMI EL-C

Special Features

Shadowless Light, High quality sterilizable handle. With special European design for ventilation of heat. Body is made of high quality fire resistant polymer. With Dual Colour LED White and Yellow.



Optional All LED in White Colour

OPTIONAL: BATTERY BACKUP



Technical Data

Intensity	40,000 Lux \pm 10%
Size of Light Field	12-30 cm
Colour Temperature	4500 K
Colour Rendering Index	93 RA
LED Life	>50000 Hrs.
Number of LED	14
Brightness Control	Touch
Diameter of Light	150mm
Power Supply	220V/50Hz AC



Wall Mounted

Wall Mounted with Extended Rod

Note: Also available Table Mounted

TMI MB-07

Special Features

Shadowless Light, With special European design for ventilation of heat. Body is made of high quality fire resistant polymer.

OPTIONAL: BATTERY BACKUP



Technical Data

Intensity	25,000 Lux \pm 10%
Size of Light Field	100 mm
Colour Temperature	4800 K
Colour Rendering Index	93 RA
LED Life	>50000 Hrs.
Number of LED	7
Diameter of Light	125 mm
Power Supply	220V/50Hz AC



Wall Mounted

Wall Mounted with Extended Rod

Note: Also available Table Mounted



SURGICAL OT TABLES



MATRIX EHO
ELECTRIC OT TABLE

ELECTRO HYDRAULIC WITH MANUAL OVERRIDE



Weight Capacity - 300 Kg



Central Floor Locking



Manual Override

STEEL QUALITY 304 MEDICAL GRADE STAINLESS STEEL

MATRIX EHO

Special Features

Engineered for increasingly complex surgical scenes, Matrix EHO comes with extreme loads in any position. The modular structure enables it to be adapted to match the size of the patient and in no time at all it can be equipped for any surgical discipline. With the characteristics of high automation low noise and high reliability, Matrix EHO can be regarded as an ideal electro-hydraulic operating table.

- The need for operating tables with higher load capacity is increasing worldwide.
- Extreme weight load capacity of 300 kg with highest safety and stability.
- Modular design tabletop tailored for various surgical discipline needs. The Easy click new mounting point enables the table adapted to wide variety of surgery and patient's height. Waterproof design. Mattress
- Standard override panel control makes the control safer.

Salient Features

- Stainless Fitting - Detachable, head, leg & Pelvic section
- In built kidney bridge
- Five Sectional Radio - Translucent Top.
- Base & Cover made of attractive, easy to clean Stainless Steel.
- Sophisticated mechanics provide smooth, step less articulation of the table Top for precise patient positioning.
- Standby Battery Back-up with recharging circuit.

Technical Data

Length of Table	1900 mm
Width of Table Top	520 mm
Minimum Height (without Mattress)	Min. 750 mm
Maximum Height (without Mattress)	Max. 1000 mm
Trendelenburg	25°
Reverse Trendelenburg	25°
Lateral Tilt	+20°
Back Section	+70°
Head Section	+60°
Leg Section	0°-90°
Floor Locking System	Center Floor Locking

TABLE POSITIONS

- Height Adjustment - Up & Down
- Lateral Tilt - Left & Right
- Trendelenburg & Reverse Trendelenburg
- Flex Position & Reflex Position

MATRIX
ELECTRIC OT TABLE



STEEL QUALITY 304 MEDICAL GRADE STAINLESS STEEL

MATRIX

Special Features

- We are providing SMPS based control box which can handle better Voltage Fluctuations, When SMPS is idle there is zero current consumption and saves power. These are as per new European and American standards where the idle power consumption should be zero and where transformer based system are outdated.
- We provide remote which is ergonomically designed to have an easy and better grip with spiral cable and it has LED backlit switch with symbolic position figures making it convenient to use even in the dark.
- We provide zero position facility i.e by pressing the single button OT Table will come to normal position.
- We provide patient reverse orientation mode when head and leg section are interchanged.
- We provide 2 memory function in control panel.
- We provide indication of battery back in the second handset.
- The Handset is designed with Back LED Indicator for better visibility.
- Head and foot section is manually operated by the means of Ratchet System.
- We provide Stainless steel Covered Base and Column Covers for easy cleaning and hygiene.
- We provide Anti Bacterial and Anti Fungal Mattress.
- The motion of table is easy with double swivel castors 100mm diameter, in which 2 castors having brakes.

Technical Data

Length of Table	1900 mm
Width of Table Top	520 mm
Minimum Height (without Mattress)	Min. 750 mm
Maximum Height (without Mattress)	Max. 1000 mm
Trendelenburg	25°
Reverse Trendelenburg	25°
Lateral Tilt	+20°
Back Section	+70°
Head Section	+60°
Leg Section	0°-90°
Floor Locking System	Center Floor Locking

Salient Features

- Center Pillar
- Stainless Fitting - Detachable, head, leg & Pelvic section
- In built kidney bridge
- Five Sectional Radio - Translucent Top.
- Base & Cover made of attractive, easy to clean Stainless Steel.
- Sophisticated mechanics provide smooth, step less articulation of the table Top for precise patient positioning.
- Standby Battery Back-up with recharging circuit.

MATRIX ADVANCE
ELECTRIC OT TABLE



STEEL QUALITY 304 MEDICAL GRADE STAINLESS STEEL

MATRIX ADVANCE

Special Features

- We are providing SMPS based control box which can handle better Voltage Fluctuations, When SMPS is idle there is zero current consumption and saves power. These are as per new European and American standards where the idle power consumption should be zero and where transformer based system are outdated.
- We provide remote which is ergonomically designed to have an easy and better grip with spiral cable and it has LED backlit switch with symbolic position figures making it convenient to use even in the dark.
- We provide zero position facility i.e by pressing the single button OT Table will come to normal position.
- We provide patient reverse orientation mode when head and leg section are interchanged.
- We provide 2 memory function in control panel.
- We provide indication of battery back in the second handset.
- The Handset is designed with Back LED Indicator for better visibility.
- Head and foot section is manually operated by the means of Ratchet System.
- We provide Stainless steel Covered Base and Column Covers for easy cleaning and hygiene.
- We provide Anti Bacterial and Anti Fungal Mattress.
- The motion of table is easy with double swivel castors 100mm diameter, in which 2 castors having brakes.

Technical Data

Length of Table	1900 mm
Width of Table Top	520 mm
Minimum Height (without Mattress)	Min. 750 mm
Maximum Height (without Mattress)	Max. 1000 mm
Trendelenburg	25°
Reverse Trendelenburg	25°
Lateral Tilt	+20°
Back Section	+70°
Head Section	+60°
Leg Section	0°-90°
Floor Locking System	Center Floor Locking

Salient Features

- Sliding Top
- Split Leg Section
- Center Pillar
- Stainless Fitting - Detachable, head, leg & Pelvic section
- In built kidney bridge
- Five Sectional Radio - Translucent Top.
- Base & Cover made of attractive, easy to clean Stainless Steel.
- Sophisticated mechanics provide smooth, step less articulation of the table Top for precise patient positioning.
- Standby Battery Back-up with recharging circuit.



Height Adjustment - Down



Height Adjustment - Up



Lateral Tilt - Left



Lateral Tilt - Right



Trendelenburg



Reverse Trendelenburg



Flex Position



Gynec Position

C-ARM COMPATIBLE ELECTRIC OT TABLE



STEEL QUALITY 304 MEDICAL GRADE STAINLESS STEEL

TMI-1201

Special Features

- Eccentric Pillars
- Stainless Fitting
- Detachable, head, leg & Pelvic section
- In built kidney bridge
- Five Sectional Radio - Translucent Top.
- Base & Cover made of attractive, easy to clean Stainless Steel.
- Sophisticated mechanics provide smooth, step less articulation of the table Top for precise patient positioning.
- Standby Battery Back-up with recharging circuit.

TABLE POSITIONS

- Height Adjustment - Up & Down
- Lateral Tilt - Left & Right
- Trendelenburg & Reverse Trendelenburg
- Flex Position & Reflex Position

Technical Data

Length of Table	1900 mm
Width of Table Top	520 mm
Minimum Height (without Mattress)	Min. 750 mm
Maximum Height (without Mattress)	Max. 1000 mm
Trendelenburg	25°
Reverse Trendelenburg	25°
Lateral Tilt	±20°
Back Section	±60°
Head Section	±60°
Leg Section	0°-90°
Floor Locking System	Manual

OPTIONAL



Low Height

Floor Locking by Remote

Manual Override

G-ARM COMPATIBLE ELECTRIC OT TABLE



 **ADDITIONAL CONTROL PANEL**

 **MEMORY FUNCTION**

 **ZERO POSITION**

STEEL QUALITY 304 MEDICAL GRADE STAINLESS STEEL

TMI-1201 ADVANCE

Special Features

- We are providing first SMPS based control Box.
- Can handle better Voltage Fluctuations.
- When idle has zero current consumption and saves power, these are as per new European and American Standards where the idle power consumption should be zero and where Transformer based systems are outdated
- We are providing a Handset and Additional control panel
- Indication of Battery Back provided in the second handset.
- The Control panel has 2 memory functions.
- The second handset has also safety key to lock the complete handset
- The Handset is designed with Back LED Indicator for better visibility.
- This is the only handset with Backlight features

TABLE POSITIONS

- Height Adjustment - Up & Down
- Lateral Tilt - Left & Right
- Trendelenburg & Reverse Trendelenburg
- Flex Position & Reflex Position

Salient Features

- Eccentric Pillars • Stainless Fitting • Detachable, head, leg & Pelvic section • In built kidney bridge • Five Sectional Radio - Translucent Top. • Base & Cover made of attractive, easy to clean Stainless Steel. • Sophisticated mechanics provide smooth, step less articulation of the table Top for precise patient positioning. • Standby Battery Back-up with recharging circuit.

Technical Data

Length of Table	1900 mm
Width of Table Top	520 mm
Minimum Height (without Mattress)	Min. 750 mm
Maximum Height (without Mattress)	Max. 1000 mm
Trendelenburg	25°
Reverse Trendelenburg	25°
Lateral Tilt	±20°
Back Section	±60°
Head Section	±60°
Leg Section	0°-90°

OPTIONAL



Low Height

Floor Locking by Remote

Manual Override

C-ARM COMPATIBLE HYDRAULIC OT TABLE



STEEL QUALITY 304 MEDICAL GRADE STAINLESS STEEL

TMI-1202

Special Features

- Eccentric Pillars
- Stainless Fitting
- Detachable, head, leg & Pelvic section
- In built kidney bridge
- Five Sectional Radio - Translucent Top.
- Base & Cover made of attractive, easy to clean Stainless Steel.
- Sophisticated mechanics provide smooth, step less articulation of the table Top for precise patient positioning.

Technical Data

Length of Table	1900 mm
Width of Table Top	520 mm
Minimum Height (without Mattress)	Min. 750 mm
Maximum Height (without Mattress)	Max. 1000 mm
Trendelenburg	25°
Reverse Trendelenburg	25°
Lateral Tilt	±20°
Back Section	±70°
Head Section	±60°
Leg Section	0°-90°
Floor Locking System	Manual

C-ARM COMPATIBLE SEMI-ELECTRIC OT TABLE



OPTIONAL: BATTERY BACKUP 

STEEL QUALITY 304 MEDICAL GRADE STAINLESS STEEL

TMI-1202 EL

Special Features

- Electric up & down by cable remote
- Eccentric Pillars
- Stainless Fitting
- Detachable, head, leg & Pelvic section
- In built kidney bridge
- Five Sectional Radio - Translucent Top.
- Base & Cover made of attractive, easy to clean Stainless Steel.
- Sophisticated mechanics provide smooth, step less articulation of the table Top for precise patient positioning.

Technical Data

Length of Table	1900 mm
Width of Table Top	520 mm
Minimum Height (without Mattress)	Min. 750 mm
Maximum Height (without Mattress)	Max. 1000 mm
Trendelenburg	25°
Reverse Trendelenburg	25°
Lateral Tilt	±20°
Back Section	±70°
Head Section	±60°
Leg Section	0°-90°
Floor Locking System	Manual

GENERAL SURGERY OT TABLE HYDRAULIC

TMI-1203



HYDRAULIC UP & DOWN

GENERAL SURGERY OT TABLE SEMI-ELECTRIC

TMI-1203 EL



OPTIONAL: BATTERY BACKUP 

ELECTRIC UP & DOWN

POSITION OF GENERAL SURGERY OT TABLE



Special Features

- Center Pillar
- Stainless Fitting
- Detachable, head, leg & Pelvic section
- In built kidney bridge
- Five Sectional Radio - Translucent.
- Base & Cover made of attractive, east to clean Stainless Steel.
- Sophisticated mechanics provide smooth, step less articulation of the table Top for precise patient positioning.

Technical Data

Length of Table	1900 mm
Width of Table Top	520 mm
Minimum Height (without Mattress)	Min. 750 mm
Maximum Height (without Mattress)	Max. 1000 mm
Trendelenburg	25°
Reverse Trendelenburg	25°
Lateral Tilt	±20°
Back Section	±70°
Head Section	±60°
Leg Section	0°-90°
Floor Locking System	Manual

SLIDING TOP ELECTRIC OT TABLE



 **SLIDING TOP**

STEEL QUALITY 304 MEDICAL GRADE STAINLESS STEEL

TMI-1204

Special Features

This Electromatic sliding top O.T Table is suitable for all kind of surgeries, i.e. general surgery, vascular surgery, cardio, neurology, urology, gynecology, proctology, laparoscopy, traumatic surgery, plastic surgery and others. The base & column of the table is made of high quality medical stainless steel (Grade - 304). Non-reflecting surface, antibacterial & easy to clean. We provide with a top sliding of 5inch back/forward. Height adjustment, Lateral Tilts, Trendelenburg, and Flex - Reflex, Chair Position and Longitudinal Sliding top are realized by Remote control.

TABLE POSITIONS

- Height Adjustment - Up & Down
- Lateral Tilt - Left & Right
- Trendelenburg & Reverse Trendelenburg
- Flex Position & Reflex Position

Salient Features

- Eccentric Pillars
- Stainless Fitting
- Detachable, head, leg & Pelvic section
- Four Sectional Radio - Translucent Top.
- Base & Cover made of attractive, easy to clean Stainless Steel.
- Sophisticated mechanics provide smooth, step less articulation of the table Top for precise patient positioning.
- Standby Battery Back-up with recharging circuit.

Technical Data

Length of Table	1900 mm
Width of Table Top	520 mm
Minimum Height (without Mattress)	Min. 750 mm
Maximum Height (without Mattress)	Max. 1000 mm
Trendelenburg	25°
Reverse Trendelenburg	25°
Lateral Tilt	±20°
Back Section	±20°
Head Section	±60°
Leg Section	0°-90°
Top Sliding	5" Reverse & 5" Forward

OPTIONAL



Low Height



Floor Locking by Remote

ELECTRIC OT TABLE WITH SLIDING TOP



ADDITIONAL CONTROL PANEL

MEMORY FUNCTION

ZERO POSITION

STEEL QUALITY 304 MEDICAL GRADE STAINLESS STEEL

TMI-1204 ADVANCE

Special Features

This Electromatic sliding top O.T Table is suitable for all kind of surgeries, i.e. general surgery, vascular surgery, cardio, neurology, urology, gynecology, proctology, laparoscopy, traumatic surgery, plastic surgery and others. The base & column of the table is made of high quality medical stainless steel (Grade - 304). Non-reflecting surface, antibacterial & easy to clean. We provide with a top sliding of 5inch back/forward. Height adjustment, Lateral Tilts, Trendelenburg, and Flex - Reflex, Chair Position and Longitudinal Sliding top are realized by Remote control.

TABLE POSITIONS

- Height Adjustment - Up & Down
- Lateral Tilt - Left & Right
- Trendelenburg & Reverse Trendelenburg
- Flex Position & Reflex Position

Technical Data

Length of Table	1900 mm
Width of Table Top	520 mm
Minimum Height (without Mattress)	Min. 750 mm
Maximum Height (without Mattress)	Max. 1000 mm
Trendelenburg	25°
Reverse Trendelenburg	25°
Lateral Tilt	±20°
Back Section	±20°
Head Section	±60°
Leg Section	0°-90°
Top Sliding	5" Reverse & 5" Forward

OPTIONAL



Low Height



Floor Locking by Remote

Salient Features

- Eccentric Pillars • Stainless Fitting • Detachable, head, leg & Pelvic section • Four Sectional Radio - Translucent Top. • Base & Cover made of attractive, easy to clean Stainless Steel. • Sophisticated mechanics provide smooth, step less articulation of the table Top for precise patient positioning. • Standby Battery Back-up with recharging circuit.

NEURO ATTACHMENT



STEEL QUALITY 304 MEDICAL GRADE STAINLESS STEEL

TMI-1205

We are ranked as one of the leading manufacturers, suppliers, exporters, traders and distributors of excellent quality Neuro Surgery Attachments. These neuro surgery attachments provide neuro surgeons stable and excellent support as they perform different medical procedures. These neuro surgery attachments are very durable made from excellent quality stainless steel and other materials. We provide ophthalmologic procedures using the narrow headrest, neurology procedures in prone position and supine position (Sugita six pin fixator and Horse Shoe).



Horse Shoe Position



Sugita Head Fixator for Supine position & Skull Pins

ALBEE'S TYPE ORTHO ATTACHMENT



TMI-1206 ALBEE'S TYPE

Special Features

Ortho Attachment allows the table to be used for the lower extremity procedures. Available at competitive prices our ortho attachment is purely made of stainless steel which resist corrosion.

Salient Features

- The Orthopedic Attachment can be used with any operating table.
- In addition, a pelvic support plate is supported on top of the frame and is formed with an asymmetrical construction.
- Stirring Instruments allows flexion/raising of legs & stirring/string ball joints locked from foot end.
- Two traction devices on sliding spot with ball joint allowing flexions & rotations of foot with traction shoe with metallic sole.
- Padded orthopedic knee crutches/provides support to the legs of the patient.



Patient positioning for Neck of femur nailing traction (D.H.S)



Femur treatment in lateral position



Tibia extension position



HANGING TYPE ORTHOPEDIC ATTACHMENT

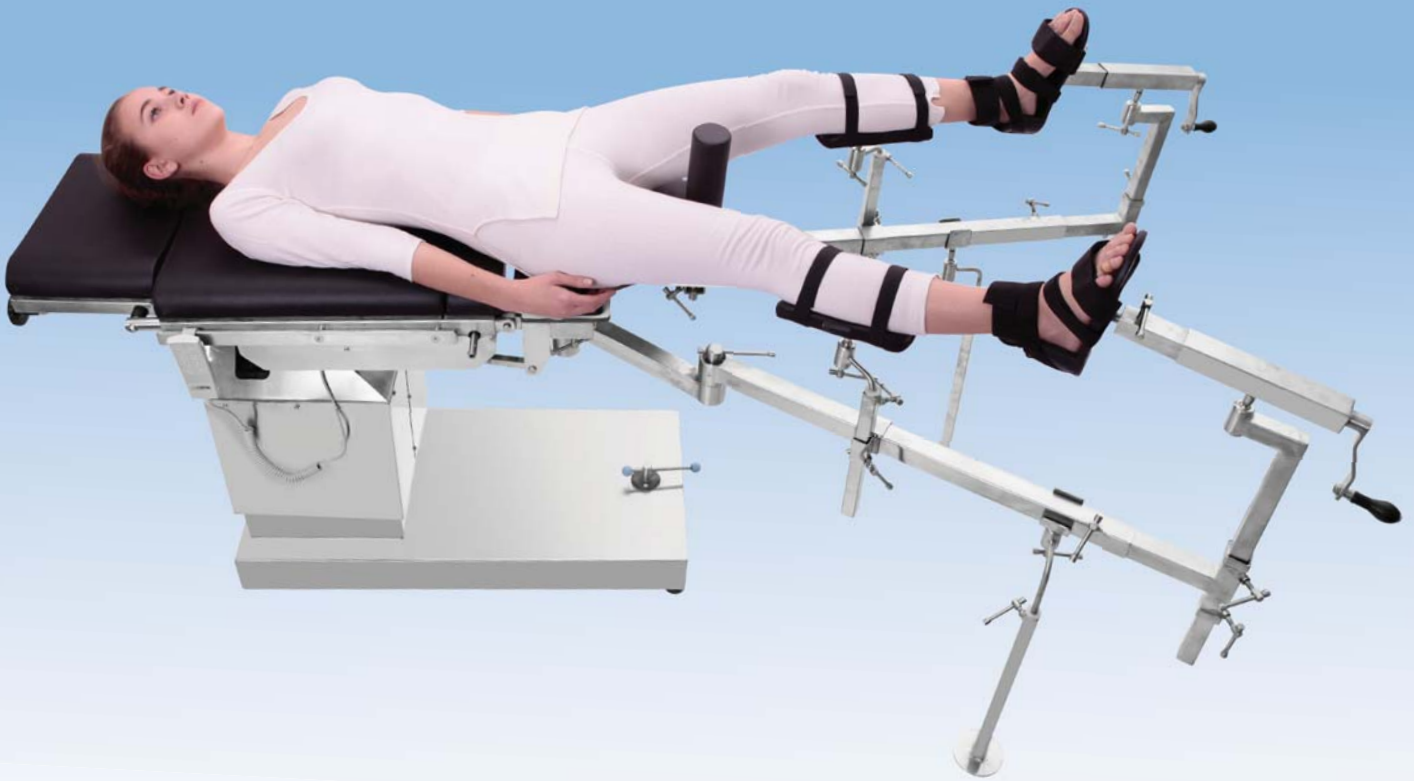

TMI-1206 HANGING TYPE

Special Features

Ortho Attachment allows the table to be used for the lower extremity procedures. Available at competitive prices our ortho attachment is purely made of stainless steel which resist corrosion.

Salient Features

- The Orthopedic Attachment can be used with any operating table.
- In addition, a pelvic support plate is supported on top of the frame and is formed with an asymmetrical construction.
- Stirring Instruments allows flexion/raising of legs & stirring/string ball joints locked from foot end.
- Two traction devices on sliding spot with ball joint allowing flexions & rotations of foot with traction shoe with metallic sole.
- Padded orthopedic knee crutches/provides support to the legs of the patient.

OPHTHALMIC ELECTRIC OT TABLE



Foot Switch (Optional)

OPTIONAL: BATTERY BACKUP 

STEEL QUALITY 304 MEDICAL GRADE STAINLESS STEEL



Instrument Tray (Optional)

TMI-1207 OPTHALMIC

Special Features

This Ophthalmic Table is specially designed for ophthalmic surgery. Three sectional table is provided with drainage system in the head section. The table has sturdy base, column made up of stainless steel, antibacterial and is easy to clean. Electromotive height with the help of lightweight handheld control unit.

Standard Accessories

- Anesthetic Screen
- IV Pole
- Hand Rest
- Mattress

Optional

- Instrument Tray

Salient Features

- Stainless Fitting
- Detachable, head & leg section
- Three Sectional Radio - Translucent Top.
- Base & Cover made of attractive, easy to clean Stainless Steel.
- Sophisticated mechanics provide smooth, step less articulation of the table Top for precise patient positioning

Technical Data

Length of Table	1900 mm
Width of Table Top	520 mm
Minimum Height (without Mattress)	Min. 750 mm
Maximum Height (without Mattress)	Max. 1000 mm
Leg Section	0°-90°

ELECTRIC GYNECOLOGICAL OBSTETRIC OT TABLE



Colour options



White Blue Pink

OPTIONAL: BATTERY BACKUP



STEEL QUALITY 304 MEDICAL GRADE STAINLESS STEEL

TMI-1208

Special Features

Obstetrics operating room table perfect for all kinds of gynecological operations. The cover for base and column is made of 304 stainless steel, good performance on anti-rust and easy to clean.

Salient Features

- Functional and versatile
- Flexibility and precision
- Hygienic design
- Easy cleaning
- User-friendly

Standard Accessories

- Arm Rest - 2 pcs.
- Birth Handle - 2 pcs.
- Mattress
- Gynae Tray

Technical Data

Length of Table	1600 mm
Width of Table Top	550 mm
Minimum Height (without Mattress)	Min. 700 mm
Maximum Height (without Mattress)	Max. 950 mm
Trendelenburg	±20°
Back Section	±70°
Floor Locking System	Manual



Gynae Tray



Birth Handle



Foot Switch (Optional)

DERMA CHAIR



OPTIONAL: BATTERY BACKUP 

STEEL QUALITY 304 MEDICAL GRADE STAINLESS STEEL

Colour options

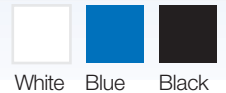

TMI-1209

Special Features

- Luxurious Styling
- Multi-position section couch
- Suitable for all Dermatology, Cosmetology & Laser Surgery.
- Stable and professional design, unlike Saloon Chairs.
- Three independent motors - for Height, Leg Section & Back Section
- Elegant upholstery and all english colours



Foot Switch (Optional)



Height Adjustment - Up / Down

Technical Data

Power	230 V 50 Hz
Size (mm)	2000 x 610 x 700
Weight	80 Kgs
Motors	3 independent
Remote	Provided

IMAGING OPERATING TABLE



STEEL QUALITY 304 MEDICAL GRADE STAINLESS STEEL

TMI-1212

Special Features

- Corded hand Remote
- Additional operating panel with colour display for electric functions at column
- Radiolucent table top, fully imaging permeable
- Table top with side rails made of S.S 304 for attachment of accessories
- Front side rails made of carbon fibre for attachment of head rest systems
- Longitudinal shifting table top
- 50 mm thick mattress

Standard Accessories

- Anesthetic Screen
- IV Pole
- Hand Rest
- Mattress

Technical Data

Length of Table	2100mm
Width of Table Top	525mm
Table Sliding	300mm

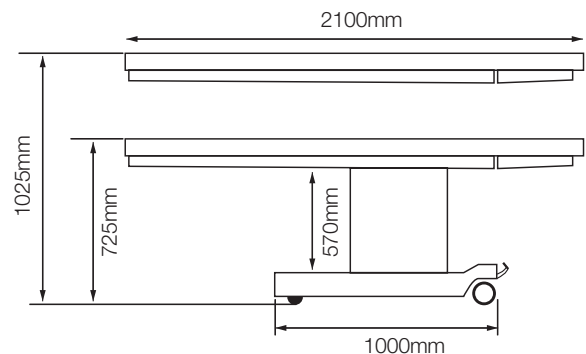
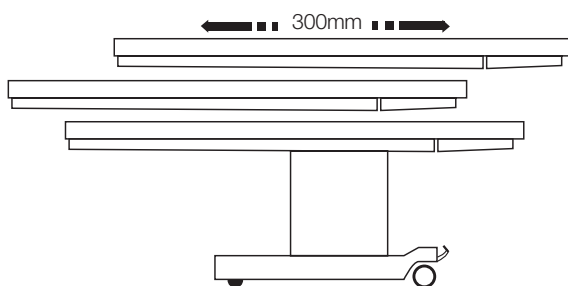

ELECTRIC ANIMAL OPERATING TABLE



OPTIONAL: BATTERY BACKUP 



Foot Switch (Optional)

TMI-1301

Special Features

- Electric up and down function.
- It is suitable for small animal's operation, such as sheep, dog etc.
- It is reasonable structured, tight, high performance, easy operation and has very strong practicability.
- Fully made of Premium Grade 304 Stainless Steel, it is heat-resistant, corrosion protective and rustproof.
- The surface of the table-top is V shaped and is smooth and easy to clean and disinfect, thus, it can avoid cross infection
- Equipped with fluid collecting through system.

Technical Data

Length of Table	1220mm (48")
Width of Table	610mm (24")

Standard Accessories

- IV Pole
- Drainage Pipe



ARM REST



SHOULDER SUPPORT



ANESTHETIC SCREEN



CLAMPS



LEG SUPPORT



MATTRESS



SPLIT LEG SECTION
OA-1



RESTRAINT BODY STRAP
OA-2



BOLSTER PILLOW
OA-3



INSTRUMENT TRAY
OA-4



FOOT SUPPORT
OA-5



**CERVICAL IN SUPINE /
LAMINECTOMY FRAME**
OA-6



HUMERUS SUPPORT
OA-7

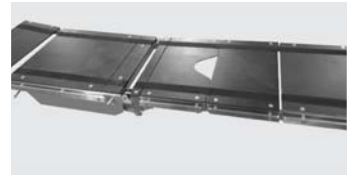

TABLE LENGTH EXTENSION
OA-8



**STEINMANN PIN
CLAMP HOLDER**
OA-9



**SPINE SURGERY USING
CUSHION SPINE FRAME**
OA-10



**ARM TRACTION DEVICE
/ PERINEAL POST**
OA-11



UROLOGY / GYNAE TRAY
OA-12



HORSE SHOE
OA-13



KNEE SUPPORT
OA-14



**FIXATOR FOR
SITTING POSITION**
OA-15



SHOULDER SURGERY
OA-16



**HAND SURGERY
TABLE**
OA-17



WIDTH EXTENSION
OA-18



WRIST LET
OA-19



X-RAY TOP
allows for inserting X-ray film
cassette from head to foot
OA-20



ACCESSORIES STAND
OA-21



**ORTHOPAEDIC
ATTACHMENT STAND**
OA-22

Awards



Winner for Best Operation Theatre Tables and O.T Light Manufacturer
Goa Healthcare Excellence Award 2016



Best Manufacturer for LED O.T Lights & Tables
7th Healthcare Leaders Forum 2017



Most Emerging Company in O.T Light & Table
7th MT India Healthcare Awards 2017



Awarded in
7th Healthcare Leaders Forum



Winner for Best Manufacturer of Surgical Lights and O.T Tables in India
Better Healthcare Awards 2018



Winner of
National Healthcare Excellence Awards, 2019

SUPPORTING MAKE IN INDIA



ISO 9001:2008
ISO 13485:2003
ISO 14001:2004
WHO/GMP
CE CERTIFIED
OHSAS 18001:2007

SINCE
1995

TECHNOMED INDIA

100+ Employees | 20 years of Experience | 6 Locations Pan-India

Offices

Corporate Office:

Plot No.3, Pocket-27, Sec-24
Rohini, Delhi-110085
INDIA

Sales Office:

TECHNOMED INDIA
Pune, Maharashtra
INDIA

Sales Office:

TECHNOMED INDIA
Chennai, Tamil Nadu
INDIA

Manufacturing Units

Mfg. Unit 1:

E-8, Sec-4
DSIDC Industrial Area
Bawana, Delhi-110039
INDIA

Mfg. Unit 2:

E-13, Sec-4
DSIDC Industrial Area
Bawana, Delhi-110039
INDIA

Phone: +91-11-40043722

Email: technomed4life@gmail.com

Customer Care No.: +91-8416010101

For more info, please visit: www.technomedindia.org

GUARANTEE

Every "Technomed" Equipment is thoroughly tested by our qualified & experienced Engineers before dispatch and carry a Guarantee of Free Repair/Replacement of any part of proven defective manufacture within one year from the date of supply.